

BAHIA

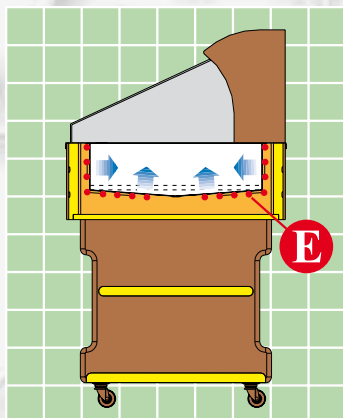

- EVAPORATORE ANNEGATO NEL POLIURETANO DELLA VASCA
- EVAPORATOR SET IN THE POLYURETHAN OF THE TANK
- EVAPORATEUR INSÉRÉ DANS LE POLYURÉTHANE DU BAC
- VERDAMPFER IM POLYURETHAN DES BECKENS EINGESETZT
- EVAPORADOR ENCASTRADO EN EL POLIURETANO DE LA CUBA



Vasca in acciaio inox AISI 316 resistente alla corrosione salina • Salt-proof AISI 316 stainless steel basin • Cuve en acier inox AISI 316 résistant à la corrosion du sel • Edelstahl AISI 316 Wanne Salzkorrosion resistant. • Cuba en acero inox AISI 316 resistente a la corrosión salina

						Uscita acqua Water outlet Sortie eau Wasseraustritt Salida agua	Piano refrigerato Refrigerated plate Tablette réfrigérée Gekühlte Fläche Estante refrigerado					
	°C	mm. (LxPxH)	Watt	DEFROST			UMC	R134a	Kg.			
Bahia 4	-2/0	1417x750x1285	480			Ø mm.20	mm. 1307x587 h. 160	230v/1/50Hz	R134a	144	-	di serie
Bahia 6	-2/0	2057x750x1285	750			Ø mm.20	mm. 195x587 h. 160	230v/1/50Hz	R134a	182	-	di serie

Dati di collaudo • Test details • Détails d'essai • Prüfungsergebnisse • Datos de ensayo • MAX = (30°C - % U.R. 55)

Prezzi vedi LISTINO a pagina 96
See PRICE LIST on page 96



BAHIA 4

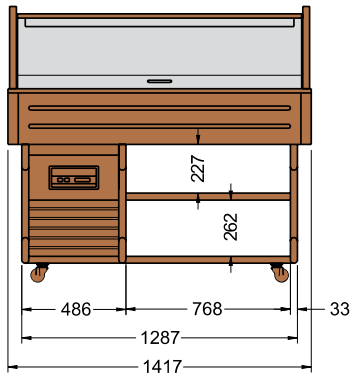

BAHIA 6

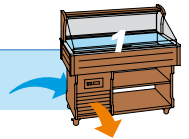
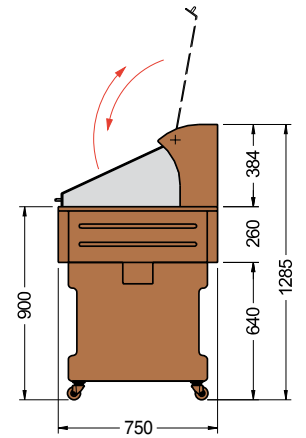
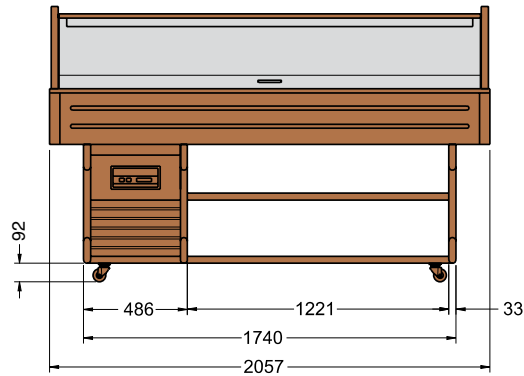

TAVOLO 750

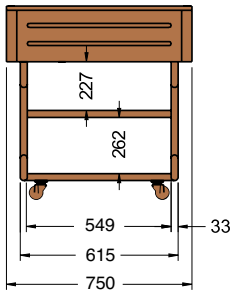

TAVOLO 1400

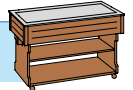
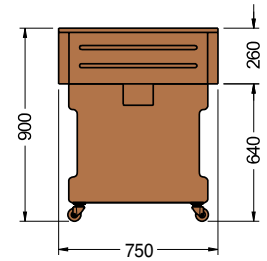
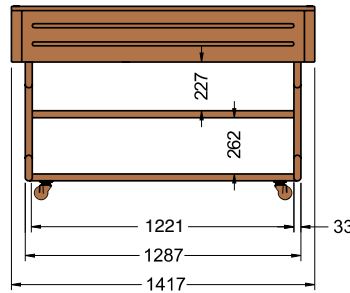

FLASH

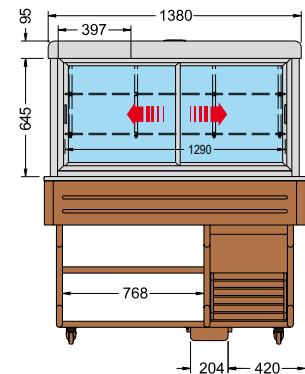
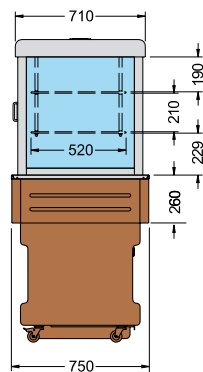
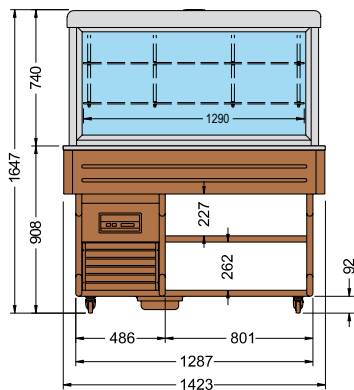

OPTIONAL

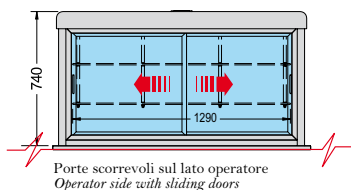

Porte scorrevoli sul lato operatore
Operator side with sliding doors

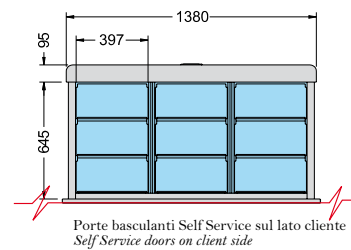
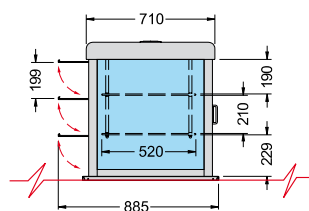

Porte basculanti Self Service sul lato cliente
Self Service doors on client side

